 **Connected**



**Simple.
Clean.
Connected.**

Dispensing Solutions

Overview

- Total overview of formulas, chemical injections and usage, plant efficiency and flow rates
- Clear and consistent documentation and reporting capabilities
- 24/7 visibility to laundry and kitchen operations
- Applications for small, medium and large facilities

Benefits of Connected Systems

- Reduce service costs up to 30%
- Immediate email alert notifications of warnings, issues and errors
- 100% asset visibility
- Significantly improve customer response time (proactive vs reactive)

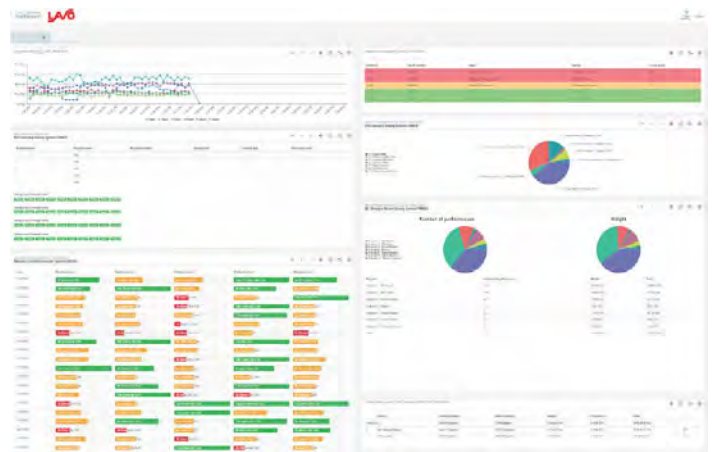

Custom Dashboard

Reporting features

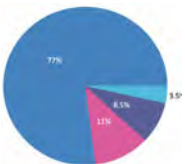

Product consumption & low level alarms



Live detailed washer and tunnel views



Asset visibility map



Detailed data views



Firehouses



Education



Nursing / Senior Care



Hotels / Motel OPL Laundry



Healthcare Co-Op



Industrial Linen & Uniform



Sport / Fitness

Connected OPL Solutions

LavoWash GoLink Pro

LAVO Simple.
Clean.
Connected.

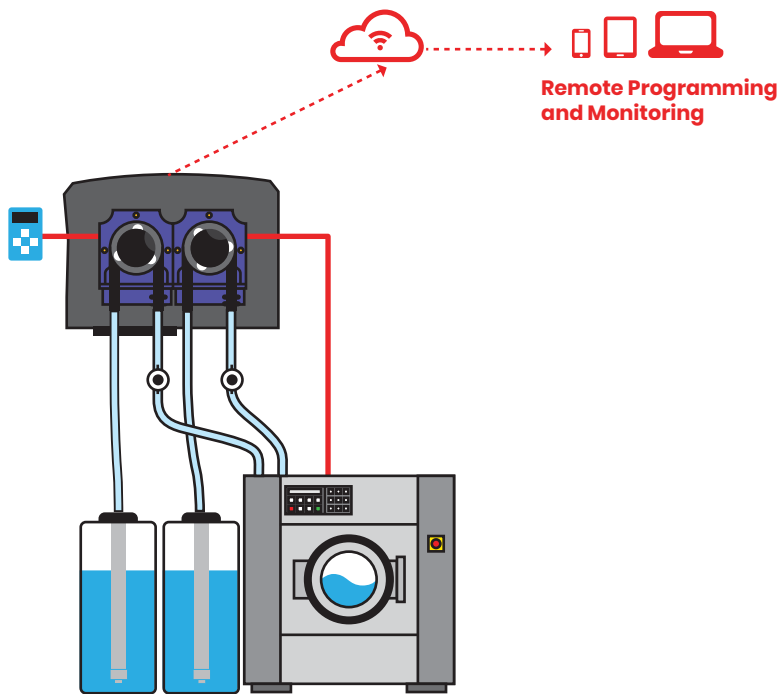

Key Features

- Controlled dosing and proof of delivery via flow meter technology
- Optional keypad for program selection
- 24/7 remote monitoring and access
- Remote calibration, programming and troubleshooting
- Cellular connectivity for uninterrupted service and safest data transmission
- Data encryption is standard
- Installation hardware included
- Program up to 32 formulas
- Optional 3rd chemical pump

Specifications

- Pump output: 10oz / min
- Voltage 120/240 VAC 50/60Hz
- Tubing recommendation: 1/4" OD
- Squeeze tube / flow meter fittings: 1/4" compression
- IP65 rated enclosure
- Isolated inputs
- Cellular based 3G / LTE
- Recommended max washer capacity: 100lbs

Spare Parts

- Squeeze tubes - EPDM, Viton, Silicone
- 24 VDC motor
- Roller assembly



Firehouses



Education



Nursing /
Senior Care



Hotels / Motel
OPL Laundry



Sport / Fitness

Connected OPL Solutions

Lavo OP-Link Pro

LAVO Simple.
Clean.
Connected.

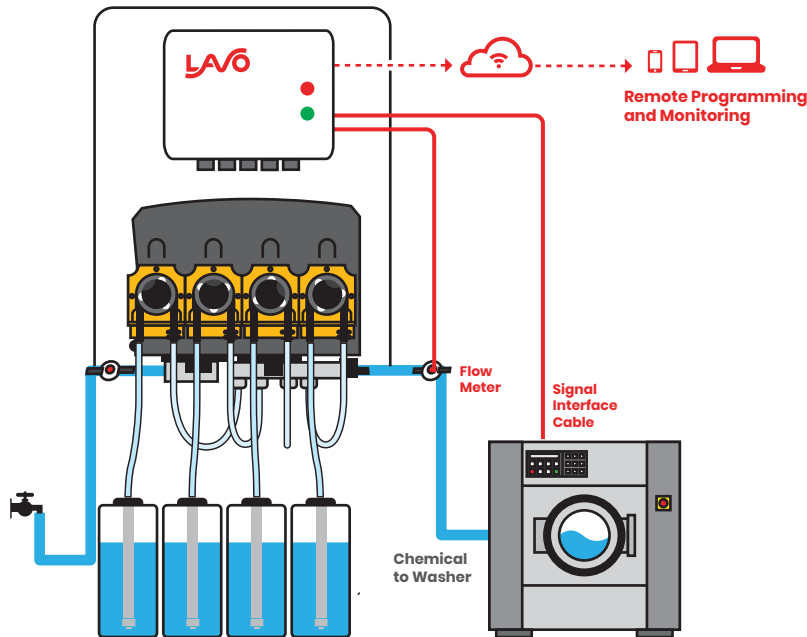

Key Features

- Complete system with controlled dosing and proof of delivery via flow meter technology
- Integrated signal interface
- 24/7 remote monitoring and access
- Remote calibration, programming and troubleshooting
- Cellular connectivity for uninterrupted service and safest data transmission
- Data encryption is standard
- Integrated water valve, flush manifold and flow meter
- Installation hardware included
- Option for up to 6 chemical pumps

Specifications

- Pump output up to 68oz / min
- Voltage 120/240 VAC 50/60Hz
- Tubing recommendation: 3/8" ID (inlet / outlet)
- Squeeze tube / flow meter fittings: 3/8" barbed compression
- IP65 rated enclosure
- Isolated inputs
- Cellular based 3G / LTE
- Recommended max washer capacity: 450lbs

Spare Parts

- Squeeze tubes - EPDM, Viton, Silicone
- 24 VDC motor
- Roller Assembly
- Flush check valves



Firehouses



Education



Nursing /
Senior Care



Hotels / Motel
OPL Laundry



Sport /Fitness

Connected Multi-washer Solutions

Lavo Multi-Link Pro

LAVO Simple. Clean. Connected.

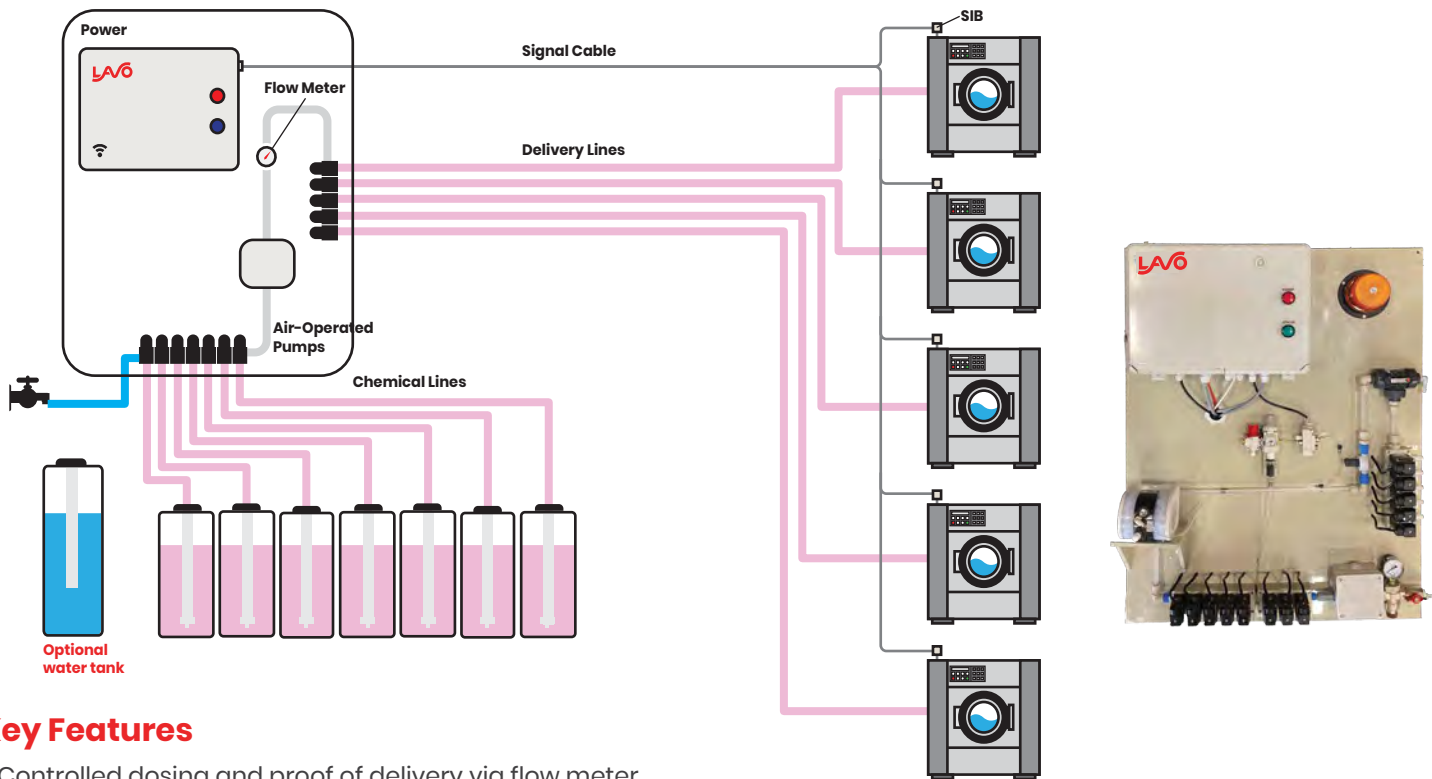

Key Features

- Controlled dosing and proof of delivery via flow meter technology
- Connects up to 5 washers and 8 chemicals on one panel
- 24/7 remote monitoring and access
- Remote calibration, programming and troubleshooting
- Cellular connectivity for uninterrupted service and safest data transmission
- Data encryption is standard
- Air assisted flush available
- Installation hardware kits available

Spare Parts

- Pneumatic or Electromagnetic pump
- 24 VDC air distributor valve
- 24 VDC electric distribution valve

Specifications

- Pump output: 1.3 gal/min (5 L/min)
- Voltage 120/240 VAC 50/60Hz
- Tubing recommendation: 3/8" ID (inlet / outlet)
- Isolated inputs 24 VDC up 230 VAC
- IP65 rated electronics enclosure
- Pneumatic or electromagnetic pumps
- Cellular based 3G / LTE
- Recommended max washer capacity: 450lbs
- Water connection: 1/2" hose barb
- Air connection: 1/4"OD push to connect



Education



Nursing / Senior Care



Healthcare Co-Op



Industrial Linen & Uniform

Lavo Tunnel Link Pro

Wash Extractors



Key Features

- Controlled dosing and proof of delivery via flow meter technology
- Connects up to 15 wash extractors
- 24/7 remote monitoring
- Remote calibration, programming and troubleshooting
- Cellular connectivity for uninterrupted service and safest data transmission

Specifications

- Pump output; 1.3 Gal/min (5 L/min)
- Voltage: 120/240 VAC 50/60 Hz
- Tubing recommendation: 3/8" ID (inlet / outlet)
- Isolated inputs 24 VDC up 230 VAC
- Cellular based - 3G / LTE
- IP 65 rated electronics enclosure
- Pneumatic or electromagnetic pumps
- Recommended maximum washer capacity - 900 lbs.
- Water connection - 1/2" hose barb x 1/2" MPT
- Air connection - 1/4" OD Push to Connect

Spare Parts

- Pneumatic or Electromagnetic pump
- 24 VDC air distributor valve
- 24 VDC electric distribution valve



Education



Nursing /
Senior Care



Hotels / Motel
OPL Laundry



Healthcare
Co-Op



Industrial
Linen & Uniform

Tunnel Washers

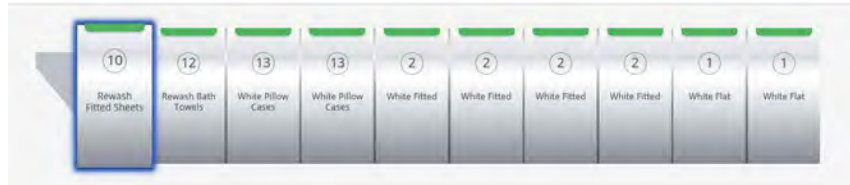

Key Features

- Controlled dosing and proof of delivery via flow meter technology
- Simultaneously dose tunnel and washer extractors from a single cabinet
- Connect up to 7 injection points
- Connect up to 15 wash extractors
- 24/7 remote monitoring and access
- Remote calibration, programming and troubleshooting
- Cellular connectivity for uninterrupted service and safest data transmission
- Free standing cabinet

Specifications

- Pump output: 1.3 Gal/min (5 L/min)
- Voltage: 120/240 VAC 50/60 Hz
- Tubing recommendation: 3/8" ID (inlet / outlet)
- Isolated inputs 24 VDC up 230 VAC
- Cellular based - 3G / LTE
- Pneumatic pumps & valves
- Recommended max washer extractor capacity - 900 lb
- Recommended maximum tunnel capacity - 250 lb pockets
- Water connection - 1/2" hose barb
- Air connection - 1/4" OD Push to Connect

Spare Parts

- Pneumatic or Electromagnetic pump
- 24 VDC air distributor valve
- 24 VDC electric distribution valve



Education



Nursing / Senior Care



Hotels / Motel OPL Laundry



Healthcare Co-Op



Industrial Linen & Uniform

Connected Warewash Solutions

LavoWare GoLink Pro

LAVO Simple.
Clean.
Connected.

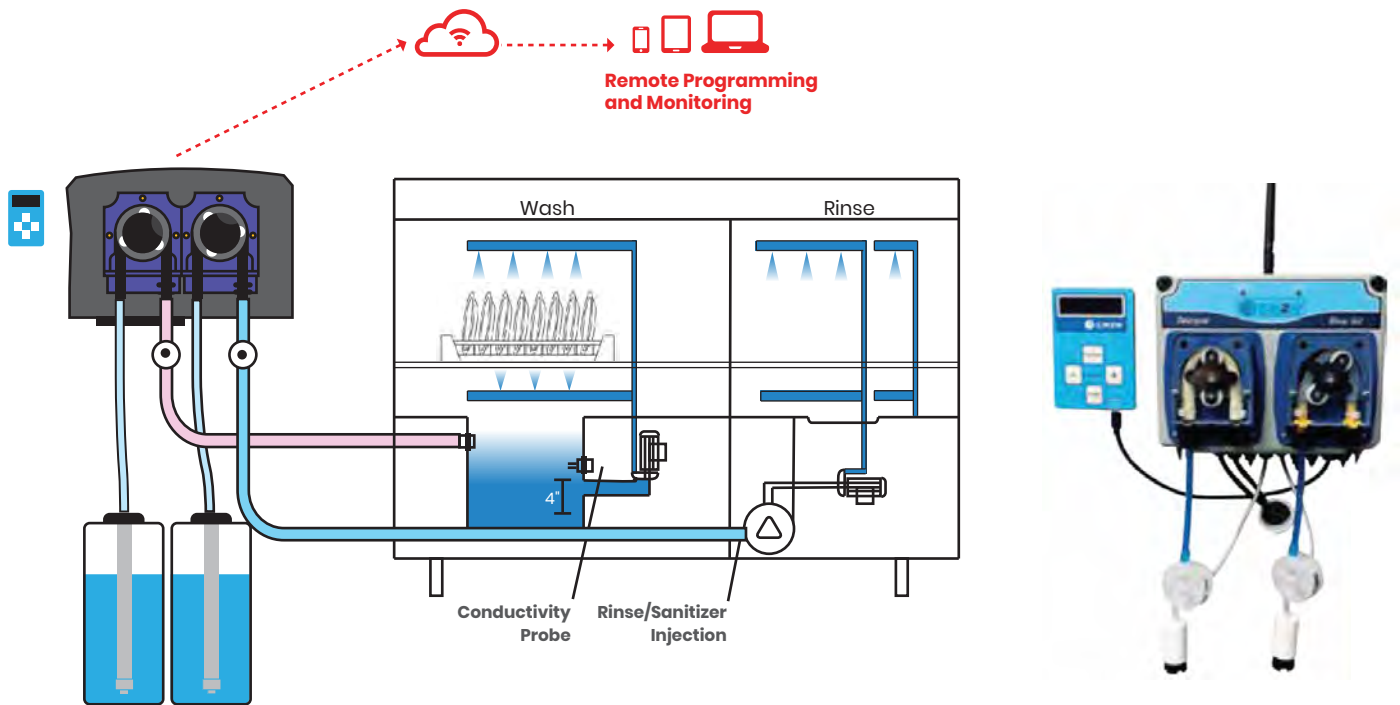

Key Features

- Exact dosing and proof of delivery via flow meter technology
- 24/7 remote monitoring and access
- Remote calibration, programming and troubleshooting
- Cellular connectivity for uninterrupted service and safest data transmission
- Data encryption is standard
- Installation hardware included
- Optional keypad for programming
- Optional third chemical pump

Specifications

- Pump output: 10 oz / min
- Voltage 120/240 VAC 50/60Hz
- Tubing recommendation: 1/4" OD
- Squeeze tube / flow meter fittings: 1/4" OD compression
- IP65 rated enclosure
- Isolated inputs
- Cellular based 3G / LTE
- Recommended for most dish machines sizes and styles

Spare Parts

- Squeeze tubes - EPDM, Viton, Silicone
- 24 VDC motor
- Roller assembly



Supermarket



Restaurant



Church and
Banquet



Convenience
Store



Catering &
Food Service

Connected Fluid Solutions

Lavo FluidLink Pro

LAVO Simple.
Clean.
Connected.

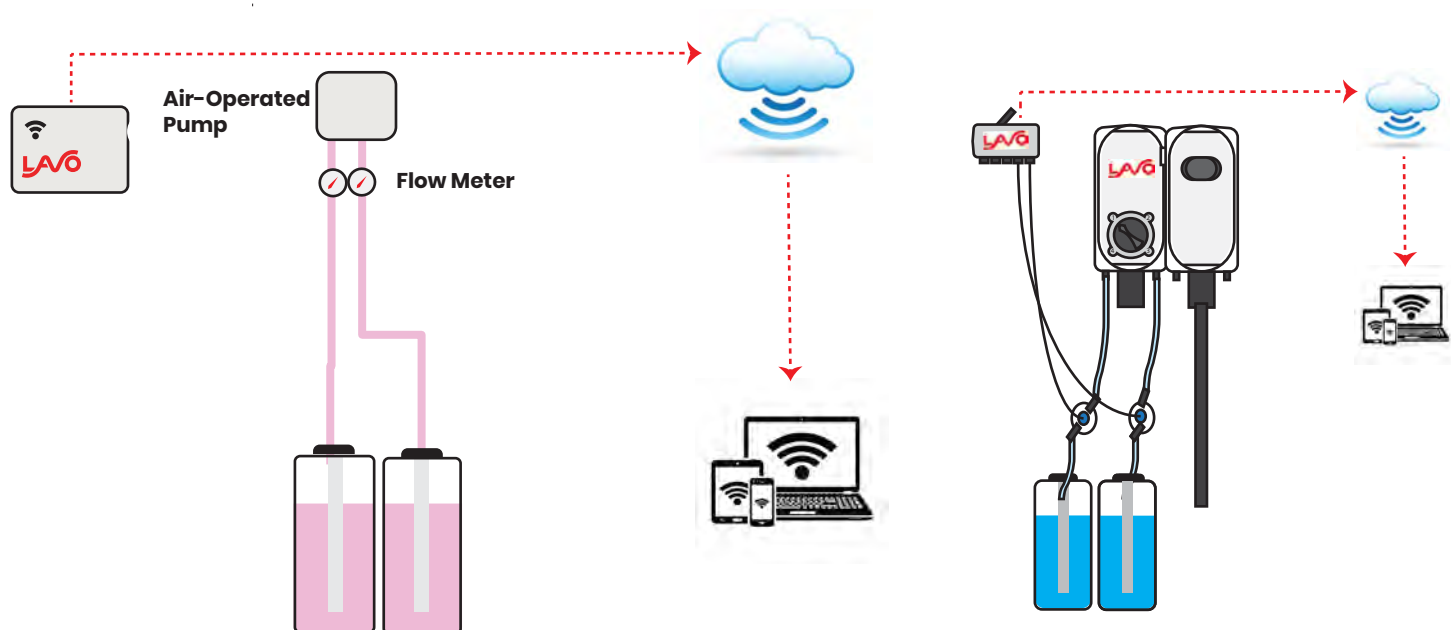

Key Features

- Controlled dosing and proof of delivery via flow meter technology
- Used to monitor fluid flow and consumption data on various dispensing equipment.
- Ability to retrofit to most existing installations
- Up to 7 products or 6 products + 1 water meter
- 24/7 remote monitoring and access
- Remote calibration, programming and troubleshooting
- Simple, easy installation
- Cellular connectivity for uninterrupted service and safest data transmission
- Dilution rates displayed in % for ratio validation
- Data encryption standard

Specifications

- Low flow meter: 0.05 oz /min (15 ml/min) to 30 oz/min (900 ml/min)
- High flow meter: 2.5oz/min (70 ml/min) to 170 oz/min (5000 ml/min)
- Voltage 120/240 VAC 50/60Hz
- Tubing recommendation: 1/4" OD
- Cellular based 3G / LTE



Firehouses



Education



Nursing /
Senior Care



Hotels / Motel
OPL Laundry



Healthcare
Co-Op



Industrial
Linen & Uniform



Sport / Fitness

Locations

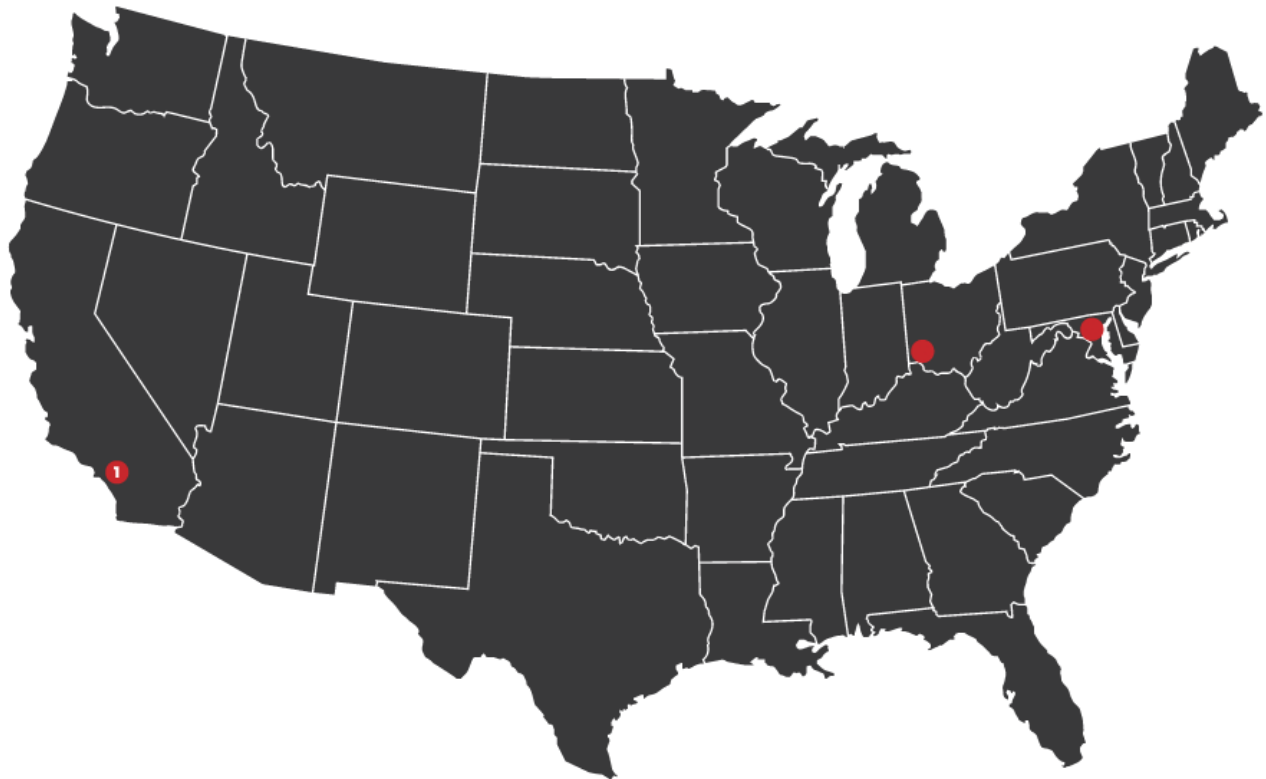

1 Lavo Worldwide Headquarters
Laguna Hills, CA
(949)377-1250
lavo@lavosolutions.com

● Sales and support
Cincinnati, OH
Baltimore, MD